

S100 Energy Meter

Connection and Test Guide

Disclaimer

The material in this document has been prepared by Sungrow Australia Group Pty. Ltd. ABN 76 168 258 679 and is intended as a guideline to assist solar installers for troubleshooting. It is not a statement or advice on any of the Electrical or Solar Industry standards or guidelines. Please observe all OH&S regulations when working on Sungrow equipment.

The S100 Energy Meter is a vital component of the Sungrow hybrid system. The Sungrow SH5K-20 Hybrid inverter comes supplied with an S100 Energy Meter. This document uses an SH5K-20 inverter as an example for explanation.

The purpose of the Energy Meter is to:

- a) Manage battery charge/discharge
- b) Export control
- c) Grid voltage sense for EPS function

The Energy Meter consists of three parts: The Energy Meter, the Current Transformer, and an RS485 cable (Supplied in the inverter box). The Energy Meter is always installed in the main switchboard.

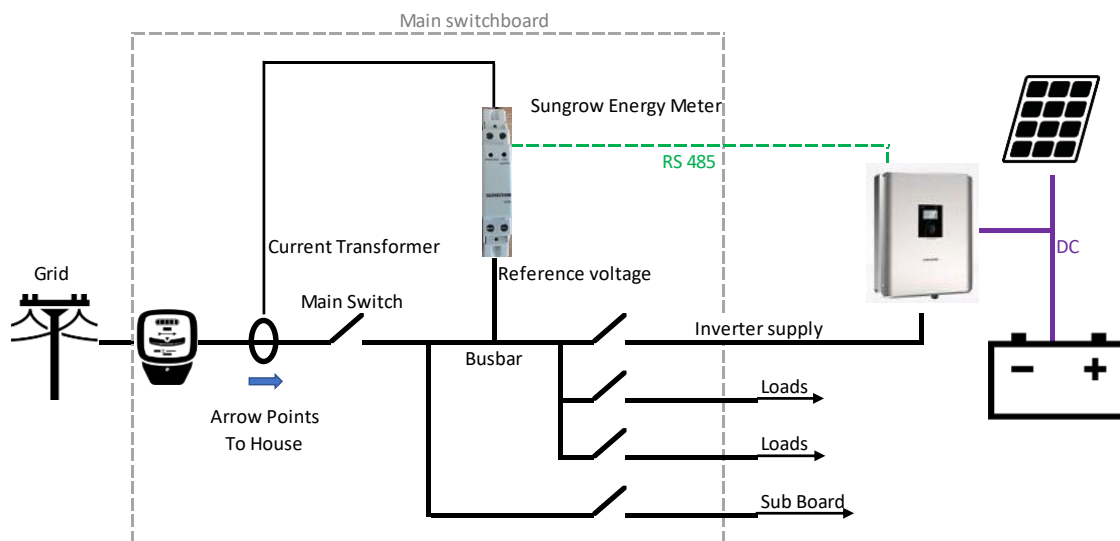

There may be an existing PV system on a sub board. Ensure that the energy meter CT is between the grid and all loads / PV systems.

Mounting: Mount the Energy Meter in the main switchboard on the DIN rail

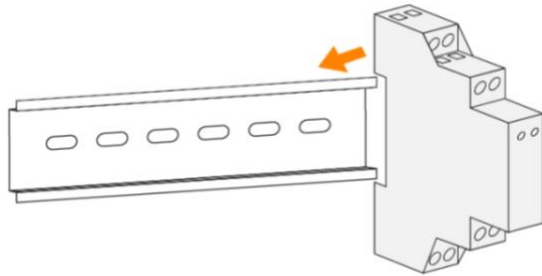

Current Transformer: The current transformer should be clipped over the consumer main active cable on the primary side of the main switch. This location is both the most convenient location and is the only point in which the total current can be measured. The arrow must always point towards the house.

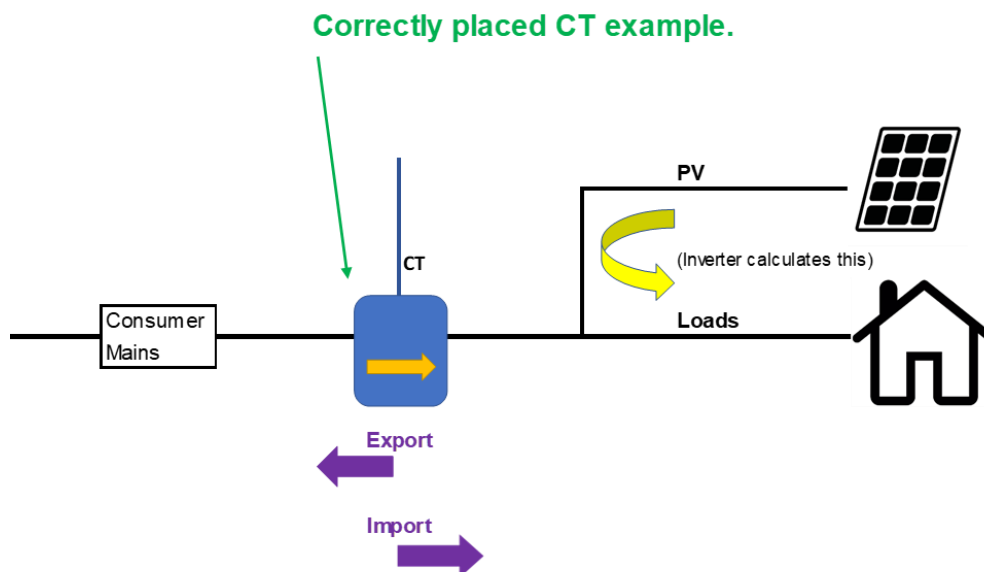

Voltage Reference Connection:

The Voltage Reference has two purposes:

- a) to sense grid voltage, and
- b) to convert the measured current into Watts.

The location of the voltage connection is important. It needs to be between the consumer side of the main switch and the primary side of all the sub circuits. This way, the voltage will go to zero in the case of a blackout or the main switch is open. It should never be able to be switched off by opening any sub-circuit switch.



Connection Diagram for the Energy Meter - Sungrow SH5K (EPS Version)

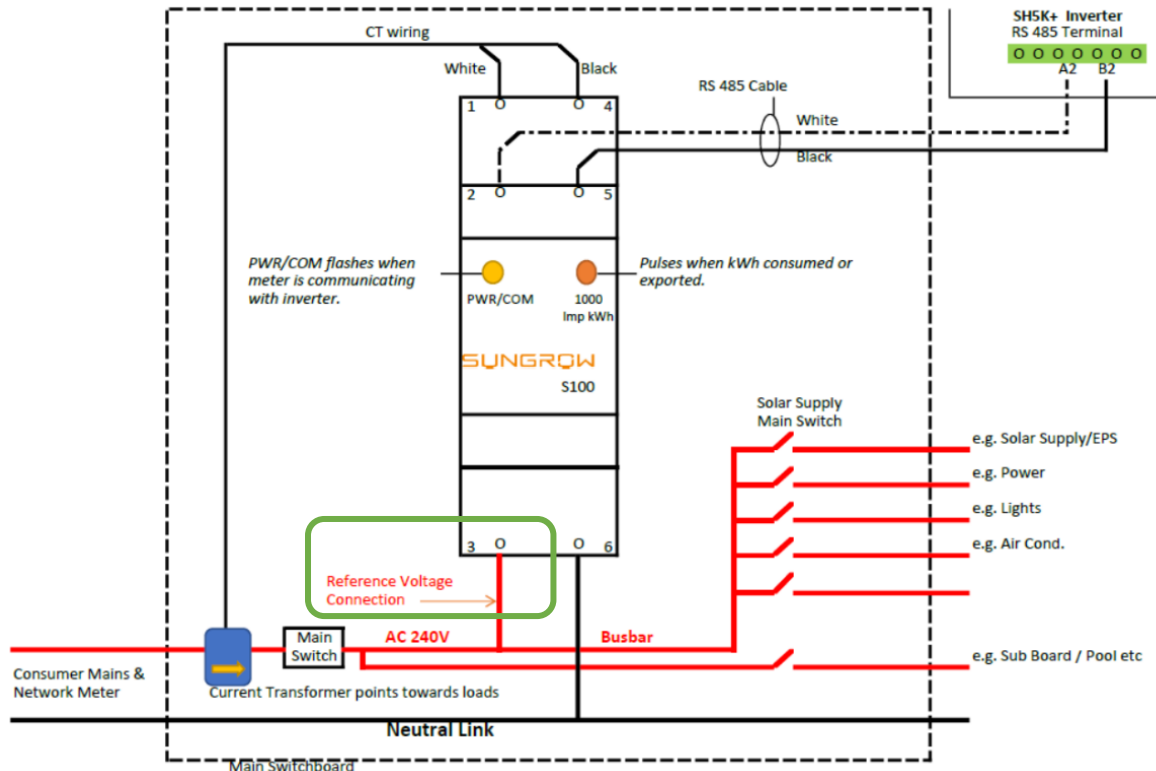

The main purpose for this connection is so that when a blackout occurs and the SH5K-20 goes into 'Off-Grid' mode, the Energy Meter will detect when grid re-establishes.

Never connect the voltage from the EPS circuits as it will cause the inverter to 'cycle' between grid and off-grid modes during EPS operation.

The yellow PWR/COM LED will be on steady if the voltage connection is correct. The LED will pulse when communication with RS 485 is established. The red LED is the watt-hour pulse.

RS 485:

A length of RS485 cable is supplied in the inverter box. The RS 485 cable sends the data to the inverter so that the inverter can calculate the import/export and consumption values. It uses this data to charge / discharge the battery bank.

If the cable run is longer than the supplied RS485 cable, Sungrow recommends you use Shielded Twisted pair (RS485) cable only.



Example RS485 cable

Connect the white (A) to terminal 2 and the black (B) to terminal 5 on the Energy meter.
 Connect white to A2 and black to B2 to the 'Meter' / RS485 terminals in the inverter.
 (If using different colour code, ensure A-A2 and B-B2)

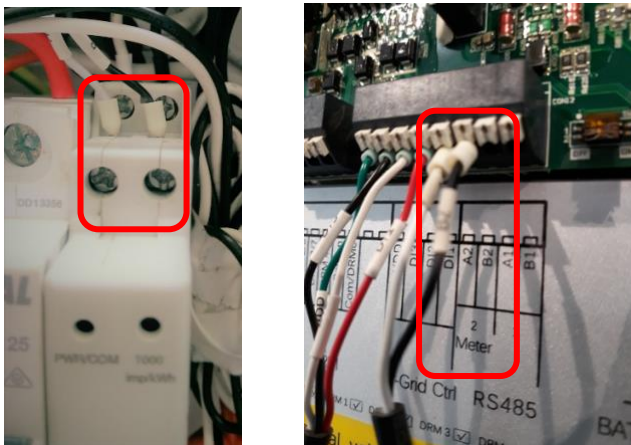

Note: If the RS 485 cable is over 50m, set the 120 Ohm terminator switch to the 'ON' position.

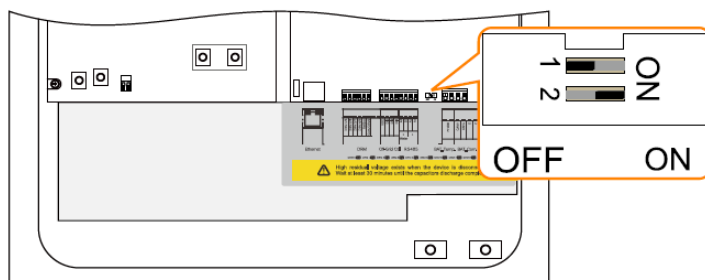

Test the system

It is recommended that the energy meter be tested as part of commissioning so as to avoid unusual readings or battery problems.

Always shut down any other PV systems as it may skew the readings in the test phase.

Switch the Inverter and energy meter on and allow to go through start-up phase.

Check to see if the yellow LED is pulsing. If the RS 485 is not connected, the display will show two dashes.

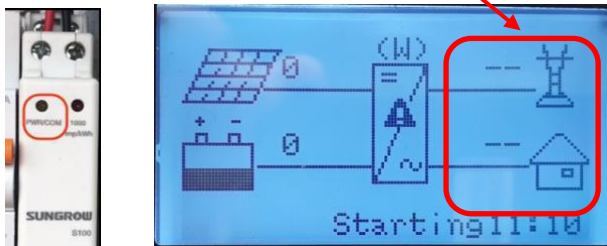

The data sent by the CT is shown on the top right icon on the LCD display

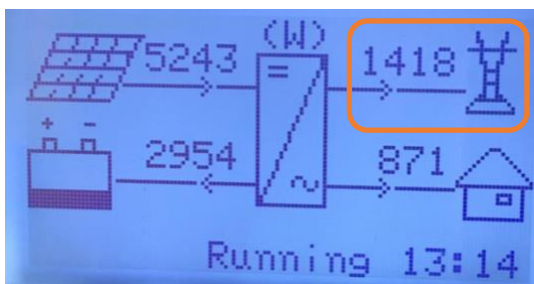

Display showing that RS485 is connected properly.

To check the correct installation of the CT:

Test 1 - Switch off all house loads and the battery (if connected), **and any existing PV system** and make sure the PV is generating. All the generation should export to the grid.

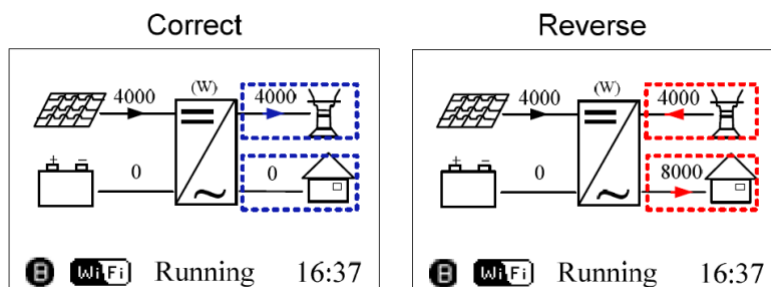

Test the AC Import/Export from house loads:

Test 2 – Key stop the inverter by going into the menu and selecting “OFF”. This will stop the DC power without shutting the inverter down.

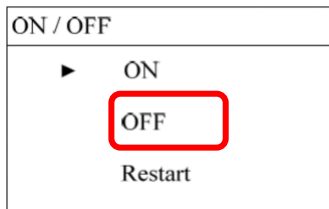
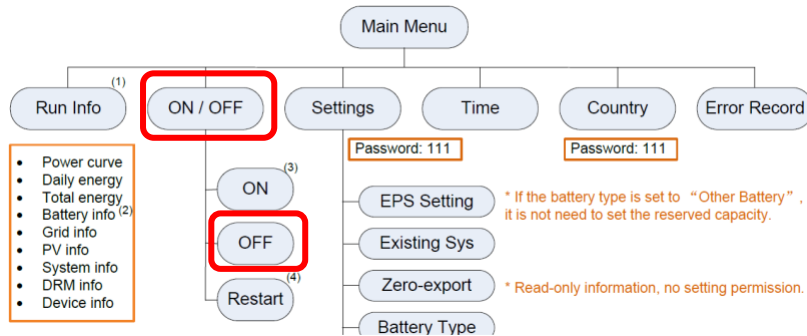

Switch some loads on i.e. Oven, bar heater etc. This is to check import, so that it is consuming from the grid. The LCD Display should look like this:

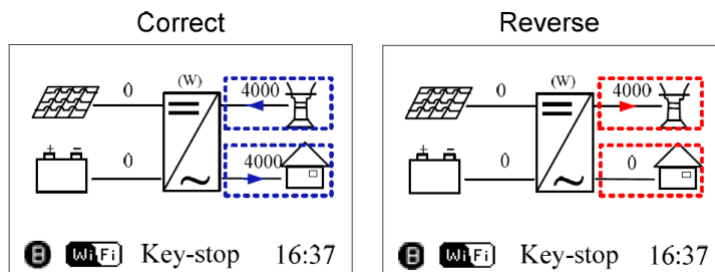

If reversed, double-check that the arrow on the CT is pointing to the house / loads, and that ALL power cables are contained, and that the CT wiring is correct polarity (see wiring diagram). **Don't forget to turn 'Key start' the inverter again.**

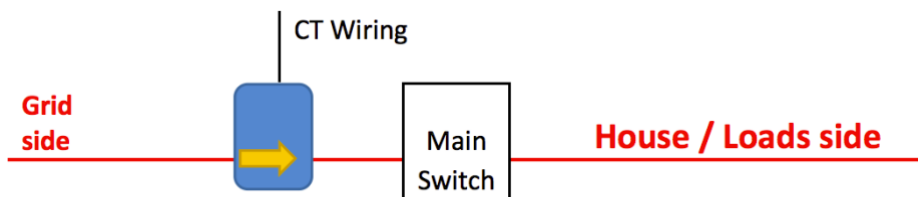

Current Transformer points towards loads

If the readings are incorrect, please double check the following:

- Is the CT arrow pointing towards the house?
- Is the CT clamped securely over the TOTAL current carrying conductor(s) for the house?
- Is the reference voltage connected to the live at the main switch?
- Is the RS 485 cable connected properly and the correct polarity?
- If the RS 485 cable is longer than 50m is the 120 Ohm DIP switch in the 'ON' position?

Note: Existing PV systems will show as energy flow from the house. In the below example, you can see the surplus AC charge the battery (No PV input).

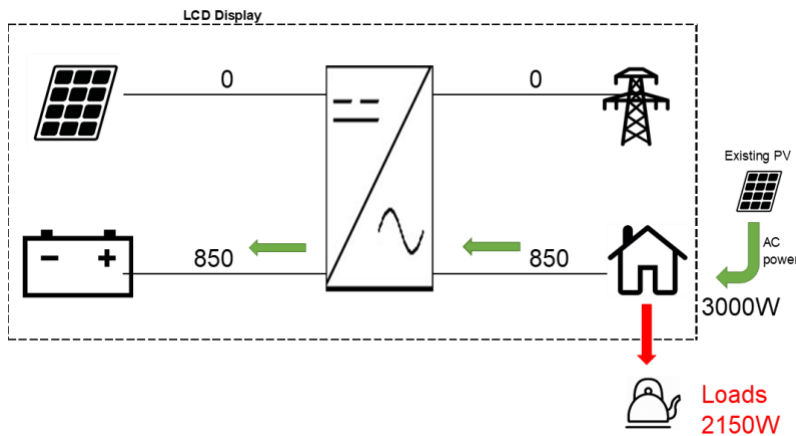

Testing the EPS box after correct energy meter installation:

Test the off-grid mode by pressing the red test button at the top left-hand corner of the EPS box (This won't interfere with the normal house loads).



An alarm will sound briefly, and after a small delay of a few seconds, the inverter will switch into off-grid mode. The LCD will confirm.

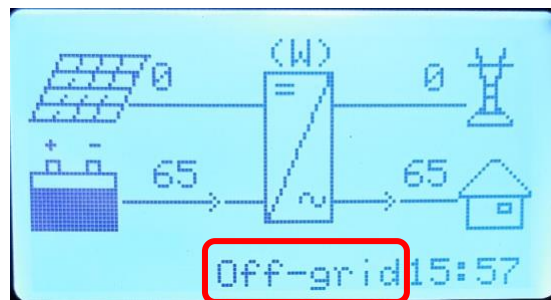

If it does not, something is not wired correctly (or there is no PV / Battery voltage).

If OK, this proves the inverter and EPS box are working. Press the red button again to re-engage grid mode, and then (after a start-up), **switch off the house main switch to simulate total blackout. You should get the same result.**

If the inverter cycles, it is likely that the reference voltage of the meter is connected to the wrong part of the live circuit and picking up 240 V (probably the EPS circuit) and sending signals to the inverter that grid is on. Re-check the connections of the energy meter.

If the issue persists, please take photos testing on site and contact Sungrow Service Department on 1800 786 476.