



More information in the QR code or  
at <http://support.sungrowpower.com/>



1-Phase PV Grid-Connected Inverter  
Quick Installation Guide

**SG2K-S / SG2K5-S / SG3K-S /  
SG3K-D / SG5K-D / SG8K-D**



1. Contents may be periodically updated or revised due to product development. The information in this guide is subject to change without notice. In no case shall this guide substitute for the user manual or related notes on the device.
2. Make sure to read over, fully understand and strictly follow the detailed instructions of the user manual and other related regulations before installing the equipment. The user manual can be downloaded by visiting the website at <http://support.sungrowpower.com/>; or it can be obtained by scanning the QR code on the side of the equipment or the back cover of this guide.
3. All installations must be performed by qualified personnel who should have training for installation and commissioning of electrical system, as well as dealing with hazards, have knowledge of the manual and of the local regulations and directives.
4. Before installation, check that the package contents are intact and complete compared to the packing list. Contact SUNGROW or the distributor in case of any damaged or missing components.
5. The cable used must be intact and well insulated. Operation personnel must wear proper personal protective equipment (PPE) all the time.
6. Any violation could result in personal death or injury or device damage, and will void the warranty.

## Safety

The inverter has been designed and tested strictly according to international safety regulations. Read all safety instructions carefully prior to any work and observe them at all times when working on or with the inverter. Incorrect operation or work may cause:

- injury or death to the operator or a third party;
- damage to the inverter or other properties.

Please follow the safety instructions related to the PV strings and the utility grid.

### DANGER

Lethal voltage!

- PV strings will produce electrical power when exposed to sunlight and can cause a lethal voltage and an electric shock.
- Only qualified personnel can perform the wiring of the PV panels.

### NOTICE

Danger to life from electric shock due to lethal voltage!

- All electrical connections must be in accordance with local and national standards.
- Only with the permission of the local utility grid company, the inverter can be connected to the utility grid.

The symbols on the inverter body are as follows.



Disconnect the inverter from all the external power sources before maintenance!



Do not touch live parts for 10 minutes after disconnection from the power sources.



Burn danger due to hot surface that may exceed 60 ° C.



Danger to life due to high voltages!  
Only qualified personnel can open and maintain the inverter.



Read the user manual before maintenance!



RCM mark of conformity.



TÜV mark of conformity.



CE mark of conformity.



Do not dispose of the inverter together with household waste.



The inverter does not have a transformer.



Additional grounding point.

### DANGER

Danger to life from electric shocks due to live voltage

- Do not open the enclosure at any time. Unauthorized opening will void warranty and warranty claims and in most cases terminate the operating license.
- When the enclosure lid is removed, live components can be touched which can result in death or serious injury due to electric shock.

Danger from electric shock due to possibly damaged inverter

- Only operate the inverter when it is technically faultless and in a safe state.
- Operating a damaged inverter can lead to hazardous situations that can result in death or serious injuries due to electric shock.

### WARNING

Risk of inverter damage or personal injury

- Do not disconnect the PV connectors and AC connector when the inverter is running. Disconnect the AC circuit breaker and set the DC load-break switch of the inverter to OFF. Wait 10 minutes for the internal capacitors to discharge. Verify that there is no voltage or current before disconnecting any connectors.

### WARNING

All the warning labels and nameplate on the inverter body:

- must be clearly visible; and
- must not be removed, covered or pasted.

### CAUTION

Risk of burns due to hot components!

- Do not touch any hot parts (such as the heat sink) during operation. Only the LCD panel and the DC switch can safely be touched at any time.

## ⚠ NOTICE

Only qualified personnel can perform the country setting. Unauthorized alteration may cause a breach of the type-certificate marking.

Risk of inverter damage due to electrostatic discharge (ESD)!

By touching the electronic components, you may damage the inverter. For inverter handling, be sure to:

- avoid any unnecessary touching; and
- wear a grounding wristband before touching any connectors.

## Scope of Delivery

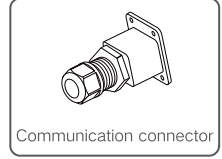
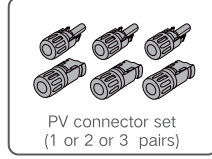
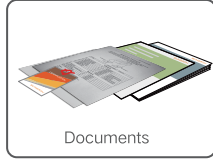
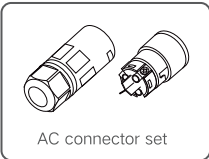
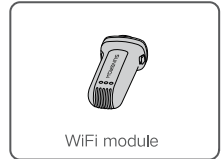
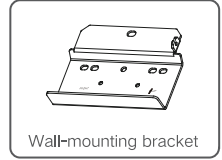
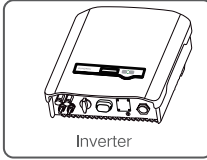
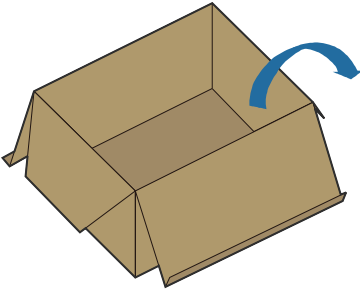

## Mounting Location

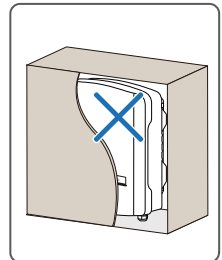
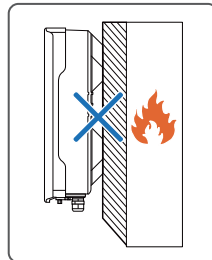
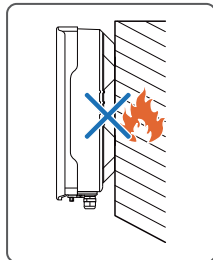
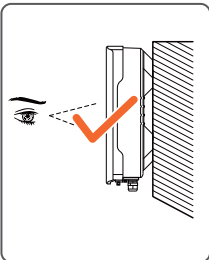
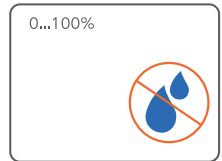
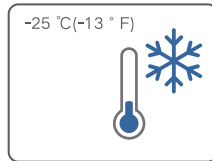
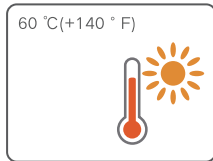

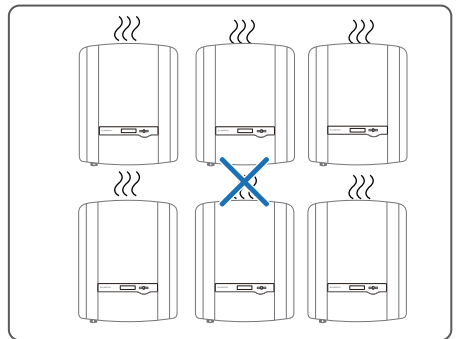
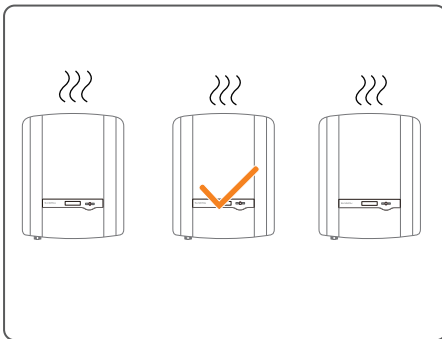
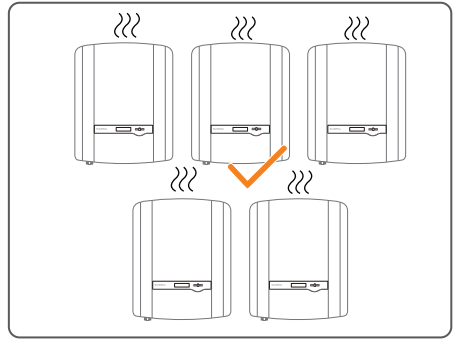
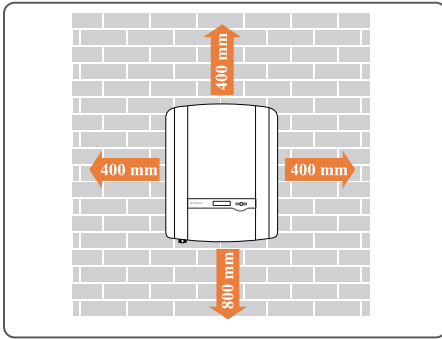
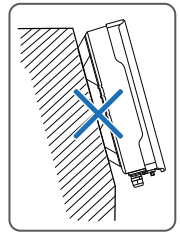
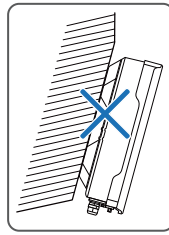
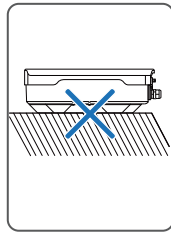
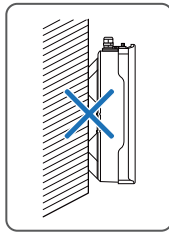
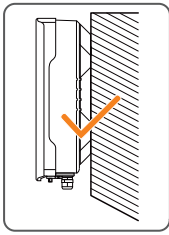

### Installation Tools

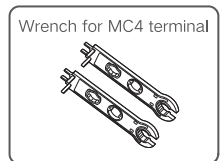
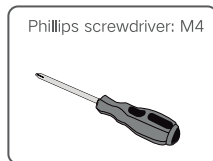
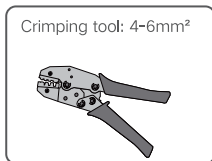
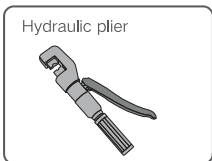
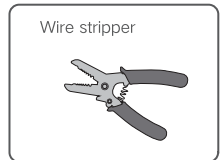
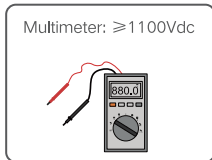

## Mounting

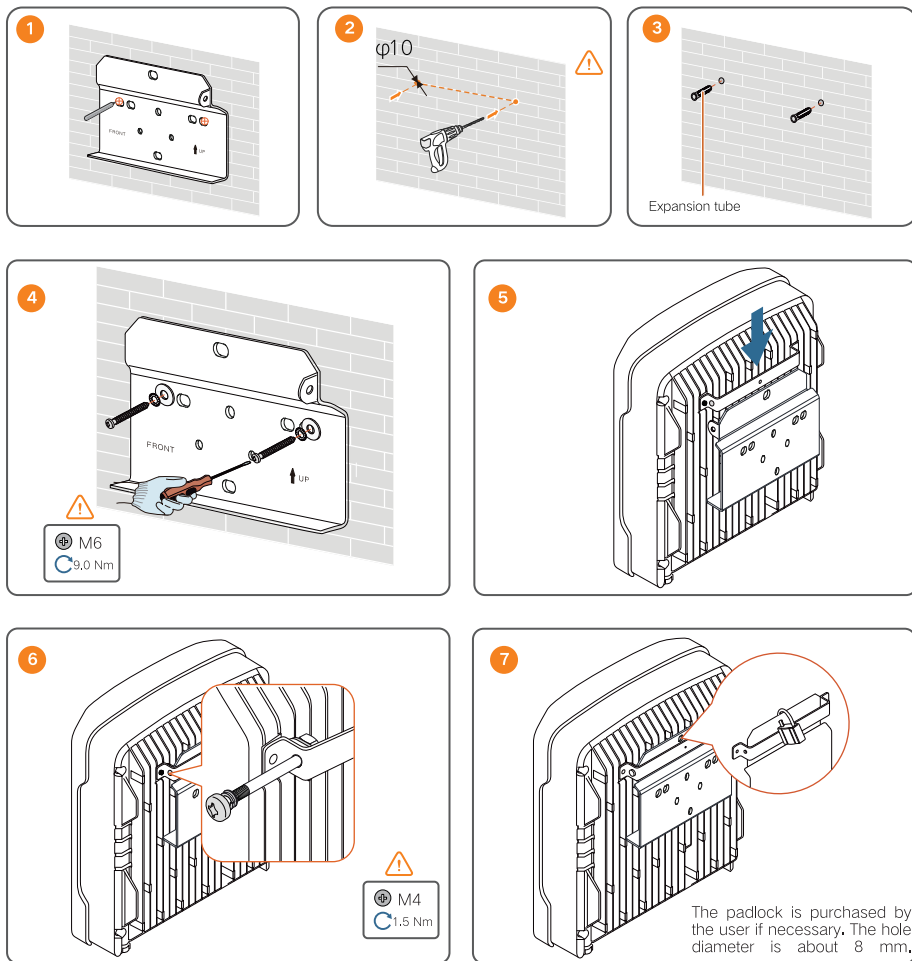

- Use appropriate mounting hardware for wall type.
- Make sure there is no utility pipes and/or cables attached to the back of the wall.
- Drill the hole with a  $\phi 10$  drill bit. The depth of the holes should be about 70 mm.

# PE

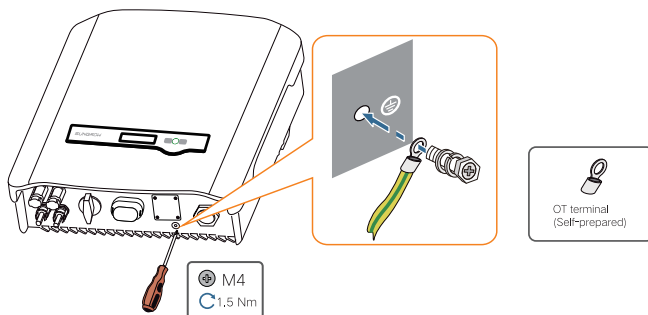

- The cross-sectional area of the PE cable shall be the same with that of the AC cable.

# AC

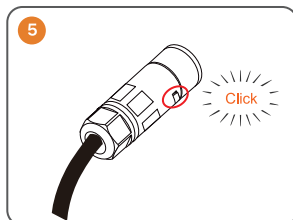
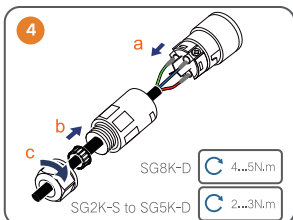
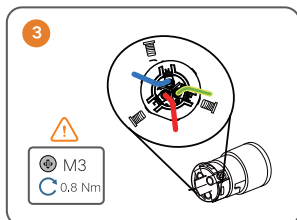
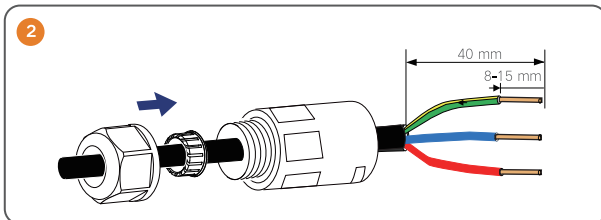
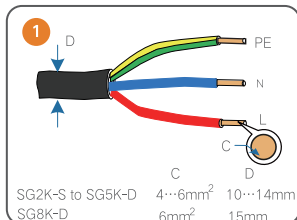
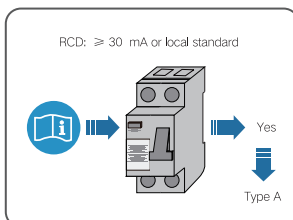
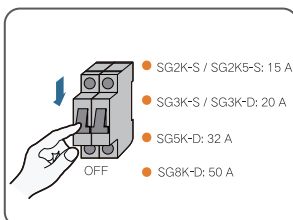
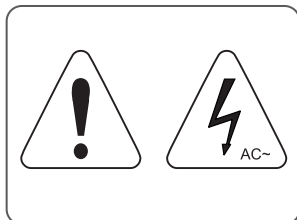



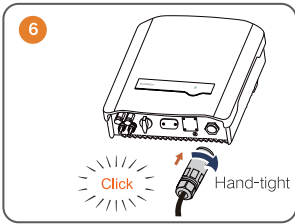

- Observe the terminal layout on the block. Do not connect the phase wires to "PE" terminal or PE wire to "N" terminal. Otherwise, unrecoverable damage to the inverter may follow.

## DC

To ensure IP65 protection, use only the supplied connector or the connector with the same ingress of protection.

The following requirements should be met, otherwise they will lead to loss of any and all warranty rights.

- (1) The maximum open voltage of each string is less than 600 V.
- (2) The maximum short circuit current of each PV input is less than inverter allowable limit.
- (3) The PV string is well insulated to ground in any case.

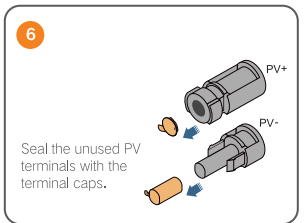
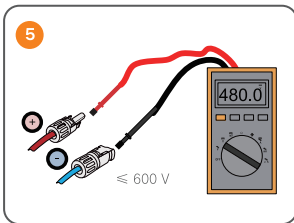
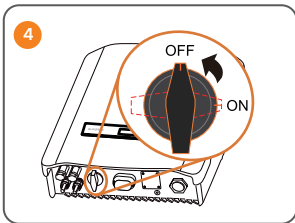
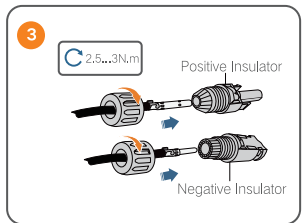
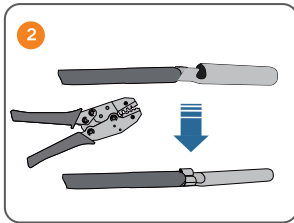
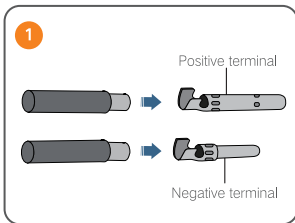
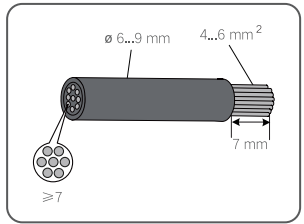
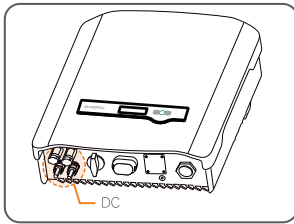
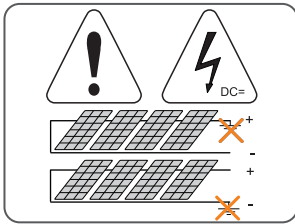

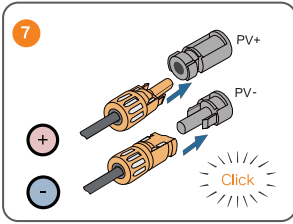

- The inverter will not function properly if any PV polarity is reversed.
- Electric arc or contactor over temperature may occur if the PV connectors are not firmly in place, and SUNGROW shall not be held liable for any damage caused.

## Wi-Fi

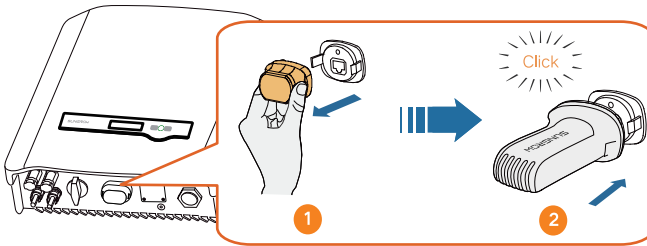

- The RS485 terminal can also be used to connect an external RS485 device. For the pin definition and waterproof procedure, please contact SUNGROW.
- Failure to comply with the requirements of wiring or waterproof will void the warranty.

## Meter

If the Sungrow Energy Meter is equipped in the PV system, proceed as follows to connect the RS485 cable.

The Smart Energy Meter and the communication cable are not included in the inverter packaging but, if ordered, delivered separately. For the connection on meter side, please refer to the meter's guide.

If the RJ45 plug is prepared on-site, use a Ethernet crimping tool to crimp wires and connect the wires to the RJ45 plug according to local standard.

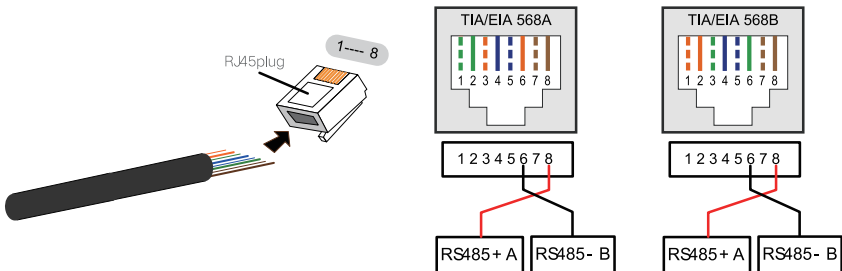

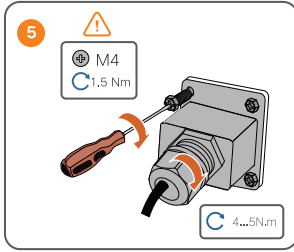
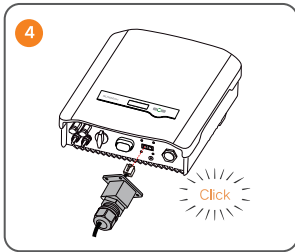
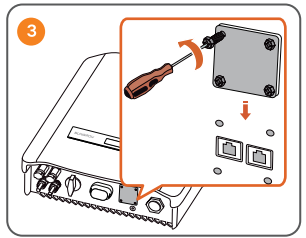
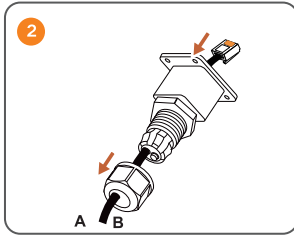
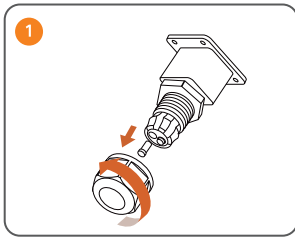

## DRM

Use a Ethernet crimper to crimp wires and connect the wires to the RJ45 plug according to local standard.

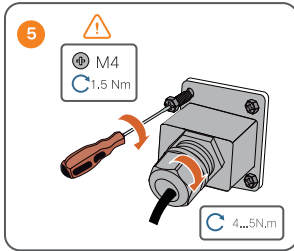
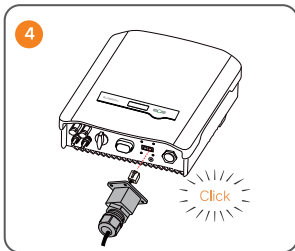
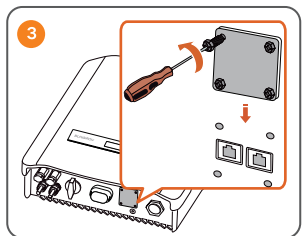
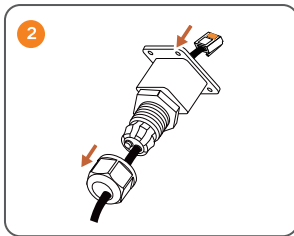
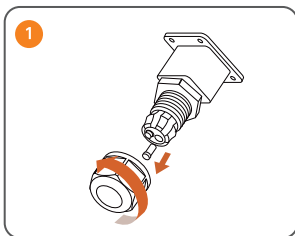
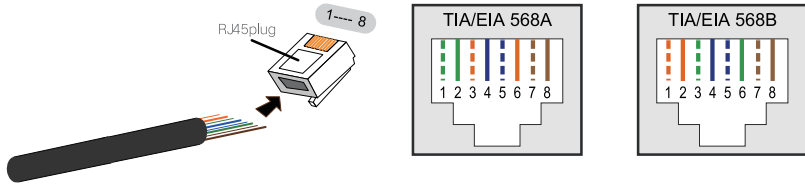

## Commissioning

### Inspection before Commissioning

No.	Content	Result	
		Yes	No
1	The inverter is accessible for operation, maintenance and service.	<input type="checkbox"/>	<input type="checkbox"/>
2	Re-check if the inverter is firmly secured.	<input type="checkbox"/>	<input type="checkbox"/>
3	Well ventilation is provided and nothing is left on top of the inverter.	<input type="checkbox"/>	<input type="checkbox"/>
4	The inverter and accessories are correctly connected.	<input type="checkbox"/>	<input type="checkbox"/>
5	Cables are properly routed and protected against mechanical damage.	<input type="checkbox"/>	<input type="checkbox"/>
6	The specification of the AC circuit breaker is reasonable.	<input type="checkbox"/>	<input type="checkbox"/>
7	Terminals unused underneath the inverter are sealed.	<input type="checkbox"/>	<input type="checkbox"/>
8	All warning signs and labels are suitably affixed and clearly visible.	<input type="checkbox"/>	<input type="checkbox"/>

### Button Function

The LCD display panel with a screen, an indicator and two buttons is on the front of the inverter. The buttons have multiple functions. Please refer to the following table before any operation of the inverter.

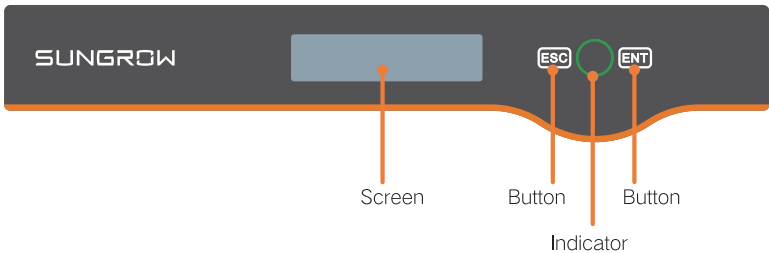

- Do not touch the hot parts (such as the heat sink) during operation. Only the buttons and the DC switch can be touched.

Button	Operation	Description
ESC	$\leq 1.2$ s	Navigate up / down or change the setting values. Hereinafter referred to as "Touch ESC" .
	$> 1.2$ s	Return to a previous menu or cancel the settings. Hereinafter referred to as "Press ESC" .

Button	Operation	Description
ENT	$\leq 1.2$ s	Move left or right, or turn pages, or view the active error/warning from the main screen. Hereinafter referred to as "Touch ENT" .
	$> 1.2$ s	Enter the sub-menu or confirm a selection or settings. Hereinafter referred to as "Press ENT" .

## Commissioning Procedure

- Step 1 Rotate the DC switch of the inverter to "ON" position.
- Step 2 Connect the AC switch (if applicable) between the inverter and the grid.
- Step 3 Connect the DC switch (if applicable) between the inverter and the PV string. If there is sufficient sunlight, the inverter will enter the running state and start to feed AC power to the grid.
- Step 4 Observe the status of the LED indicator.

LED Status	Description	
Green	Steady on	The inverter is running normally, or with a warning, or with power limitation.
	Blinking once every 1 s	In the status of standby, or start up, or off via LCD.
Red	Steady on	Inverter fault.
	Blinking once every 0.2 s	Grid fault.
	Blinking once every 1 s	PV fault.

- Step 5 Find the error codes.

If the LED indicator is blinking red, there are two methods to check the state and find the error codes.

### Method 1 (Inverter screen):

The current error code will be displayed on the main screen.



Proceed as follows to view the error record.

Main Screen (Press ENT)→Menu (Touch ESC)→ Error Record (Press ENT )

Scroll pages by touching ENT / ESC.

Press ESC to exit.

		P1/7
1	15/01/21 09:10:12	010
2	15/01/21 09:10:08	004
3	15/01/21 09:11:08	005

Description of status on the main screen:

Status	Description
Running	After being energized, the inverter tracks the PV array ' s maximum power point (MPP) and feeds the AC power to grid. This mode is the normal mode.
Startup	The inverter is initializing and synchronizing with the grid.
Standby	The inverter waits for sufficient sunlight, then the DC voltage recovers.
Error xxx	If an error occurs, the inverter will automatically stop operation, trigger the AC relay and show “ Error xxx ” on the LCD with the circle indicating red (xxx is the error code). Once the error is cleared in recovery time, the inverter will automatically resume running.
Turn off	The inverter will stop running by manual “ OFF ” through the LCD menu or with the DRM0 command from external DRED. Set to “ ON ” if you want to restart the inverter.
Upgrading	The DSP or LCD firmware is upgrading.

### Method 2 (iSolarCloud App):

Scenario 1

Use your smart phone to scan the QR code as shown on the right to download and install the App.

Scenario 2

Search for iSolarCloud in your App Store (iOS) or in Google Play (Android) to download and install the App.

Scenario 3

Download the App at [http://www.isolarcloud.com/AppStore\\_en\\_US.html](http://www.isolarcloud.com/AppStore_en_US.html).



iSolarCloud

## LCD Operation

### Main Menu

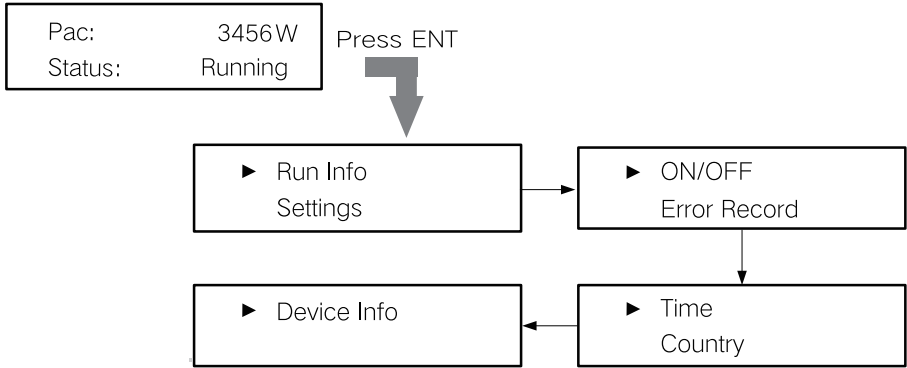

When there is no button operation for more than 8 seconds on the main screen, the displayed information will automatically cycle through to provide additional data: Main screen, energy, PV data, utility grid data. The screen will cycle every 2 seconds. Press any button to quit this mode.

If there is no button operation for:

- 1 minute, LCD backlight will be automatically deactivated;
  - 2 minutes, system will return to the default menu (main screen).
- Please read over the user manual for the detailed instructions.

### Advanced Settings

The parameter settings are protected with a password.

Main Screen (Press ENT) → Menu (Press ESC) → Settings (Press ENT)

- Only qualified personnel are permitted to set the protection parameters.

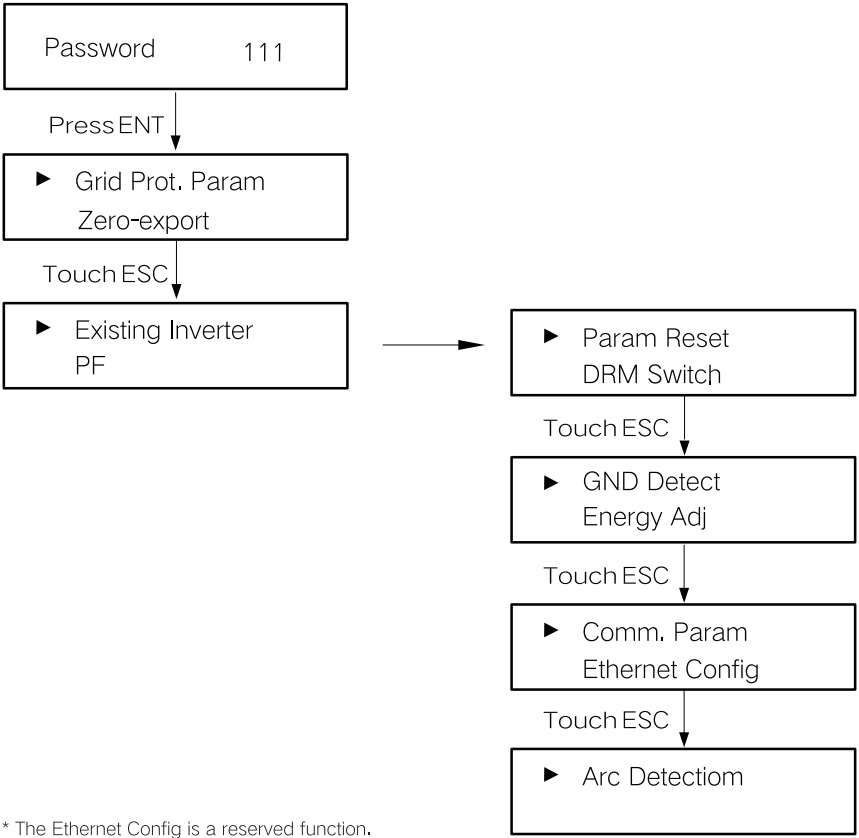

\* The Ethernet Config is a reserved function.



### LED Indicator

When the inverter indicator cannot be lit or suddenly goes out, blinking red, proceed as follows for the troubleshooting.

1. Disconnect the AC circuit breaker.
2. Rotate the DC switch to "OFF" position.
3. Check the PV connection.
4. Check whether the voltage of PV input exceeds the inverter startup voltage 120 V.
5. Check the grid voltage or frequency if they comply with the connection conditions.

If the fault persists, please contact Sungrow Service Dept.

### Errors on the App or LCD Screen

Refer to the inverter user manual for other errors.

Code	Description	Cause & Troubleshooting
002/015	Grid over-voltage (stage I/II)	Grid abnormal. Please contact your local installer.
003	Grid transient over-voltage	
014	10-minute grid over-voltage	
004/005	Grid under-voltage (stage I/II)	
053	Grid voltage redundancy detection abnormal	
054	Grid frequency redundancy detection is abnormal	
008/101	Grid over-frequency (stage I/II)	
009/102	Grid under-frequency (stage I/II)	
010	Grid failure (islanding)	This is an "islanding" fault, which indicates the inverter could not detect the grid power. Please ensure all AC circuit breakers are rotated to "ON". If an issue persists, contact Sungrow.
016	Too high PV voltage	PV abnormal. Please contact your local installer.
028/029	Reverse polarity (PV1/PV2)	The positive and negative cables are reversed. Please contact your local installer.
012	Leakage current over-current	Something wrong with the PV panels or excessive air humidity. Please contact your local installer.
039	Low insulation resistance of PV to earth	1. Check whether there is a reliable inverter grounding line. 2. Check whether the positive and negative of PV panels is short-circuited with ground lead. 3. Wait a moment for inverter recovery. 4. If the fault occurs repeatedly, contact Sungrow Service Dept.
043	Inverter inner under-temperature	The inverter will recover once the ambient temperature rises above -25°C.
056	Leakage current redundancy detection abnormal	Check the PV strings for ground fault.
106	Abnormal grounding	This is an earth fault. Please contact your installer to check your solar system.

## Technical Data

Parameter	SG2K-S	SG2K5-S	SG3K-S	SG3K-D	SG5K-D
Input Data					
Max. PV input power	3000 W	3200 W	4000 W	4000 W	6500 W
Max. PV input voltage	600 V				
Startup voltage	120 V				
Nominal input voltage	360 V				
MPP voltage range	90 V – 560 V				
MPP voltage range for nominal voltage	210 V – 480 V	260 V – 480 V	310 V – 480 V	160 V – 480 V	260 V – 480 V
No. of MPPTs	1			2	
PV strings per MPPT	1			1 / 1	
Max. PV input current (DC1/DC2)	12.5A		25 A (12.5 A / 12.5 A)		
Max. PV short-circuit current	15 A		30 A (15 A / 15 A)		
Max. inverter backfeed current to PV string	0 A				
Output Data					
Nominal AC output power	2000 W	2500 W	3000 W	3000 W	4999 W
Max. AC output apparent power	2000 VA	2500 VA	3000 VA	3000 VA	4999 VA
Max. AC output current	9.1 A	11.3 A	13.7 A	13.7 A	21.7 A
Max. inrush current peak value / duration	8 A / 12 ms			10 A / 12 ms	
Max. output fault current peak value / duration	80 A / 3.2 ms			100 A / 3.2 ms	
Max. output over-current protection	25 A			25 A	32 A
Nominal grid voltage/frequency	230 Vac (single phase) , 50 Hz / 60 Hz				
Voltage/frequency range	180 Vac – 276 Vac , 45 Hz – 55 Hz / 55 Hz – 65 Hz (this may vary with grid standards)				
Total harmonic distortion (THD)	< 3 % (of nominal power)				
DC current injection	< 0.5 % (of nominal current)				
Power factor	>0.99 at default value at nominal power (adj. 0.8 leading to 0.8 lagging)				
Protection					
PV reverse connection protection	Yes				
AC short circuit protection	Yes				
Leakage current protection	Yes				
Anti-islanding protection	Yes (frequency shift)				
Grid / PV string current monitoring	Yes				
DC switch	Yes (meet AS60947.3:2018)				
AFCI	Yes				
Overvoltage category	III [AC], II [DC]				
Surge protection	DC Type II / AC Type II				
Safety protection class	I				
System Data					
Max. efficiency	98.2 %	98.2 %	98.2 %	98.4 %	98.4 %
Max. European efficiency	97.2 %	97.5 %	97.7 %	97.7 %	98.0 %
Isolation method	Transformerless				
Ingress protection rating	IP65				
Pollution degree	Outside / inside the enclosure: 3 / 2				
Power loss in night mode	< 3 W				
Operating ambient temperature / relative humidity	-25°C to +60°C , 0 to 100% (non-condensing)				
Cooling method / Max. altitude	Natural cooling, 4000 m (derating when > 2000 m)				
Display / communication	Graphic LCD, Wi-Fi				
Connector	PV: MC4, AC: plug and play connector				

Parameter	SG8K-D
Input Data	
Max. PV input power	10400 W
Max. PV input voltage	600 V
Startup voltage	120 V
Nominal input voltage	360 V
MPP voltage range	90 V – 540 V
MPP voltage range for nominal voltage	275 V – 480 V
No. of MPPTs	2
PV strings per MPPT	1 / 2
Max. PV input current (DC1/DC2)	12,5 A / 25 A
Max. PV short-circuit current	15 A / 30 A
Max. inverter backfeed current to PV string	0 A
Output Data	
Nominal AC output power	8000 W
Max. AC output apparent power	8000 VA
Max. AC output current	34,8 A
Max. inrush current peak value / duration	25 A / 12 ms
Max. output fault current peak value / duration	93 A / 3,2 ms
Max. output over-current protection	40 A
Nominal grid voltage/frequency	230 Vac (single phase) , 50 Hz / 60 Hz
Voltage/frequency range	180 Vac – 276 Vac , 45 Hz – 55 Hz / 55 Hz – 65 Hz (this may vary with grid standards)
Total harmonic distortion (THD)	< 3 % (of nominal power)
DC current injection	< 0,5 % (of nominal current)
Power factor	>0,99 at default value at nominal power (adj. 0,8 leading to 0,8 lagging)
Protection	
PV reverse connection protection	Yes
AC short circuit protection	Yes
Leakage current protection	Yes
Anti-islanding protection	Yes (frequency shift)
Grid / PV string current monitoring	Yes
DC switch	Yes (meet AS60947.3:2018)
AFCI	Yes
Overvoltage category	III [AC], II [DC]
Surge protection	DC Type II / AC Type II
Safety protection class	I
System Data	
Max. efficiency	98,5 %
Max. European efficiency	98,0 %
Isolation method	Transformerless
Ingress protection rating	IP65
Pollution degree	Outside / inside the enclosure: 3 / 2
Power loss in night mode	< 3 W
Operating ambient temperature / relative humidity	-25°C to +60°C , 0 to 100% (non-condensing)
Cooling method / Max. altitude	Natural cooling, 4000 m (derating when > 2000 m)
Display / communication	Graphic LCD, Wi-Fi
Connector	PV: MC4, AC: plug and play connector

